

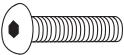





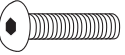

Návod na montáž bránky Exkluzív "EXP"

| | | | | | | | |
|--|--|--|---|---|--|---|---|
| <p>A</p>  <p>Skrutka M6 x 20 - 6 ks</p> | <p>B</p>  <p>Podložka M6 - 6 ks</p> | <p>C</p>  <p>Skrutka M8x20 - 6 ks</p> | <p>D</p>  <p>Skrutka TEX 4,2 x 19 - 2 ks</p> | <p>E</p>  <p>Záves nastaviteľný - 2 ks</p> | <p>F</p>  <p>Zámok - 1 ks</p> | <p>G</p>  <p>Doraz Bránky - 1 ks</p> | <p>H</p>  <p>Papierová šablóna - 1ks</p> |
|--|--|--|---|---|--|---|---|

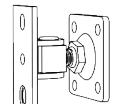

1 Výplň osadíme do rámu, vycentrujeme a uchytíme pomocou skrutiek A a podložiek B.

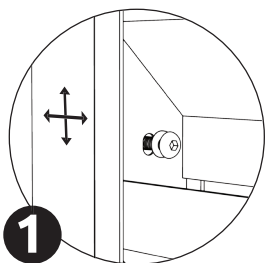
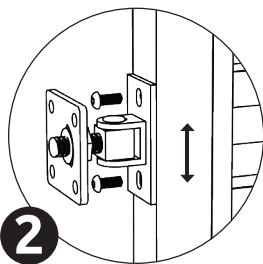

2 Záves E uchytíme k rámu pomocou skrutiek C.

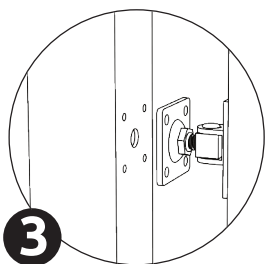

3 Pomocou priloženej šablóny H označíme miesta vrtania otvorov v stĺpiku pre uchytienie závesov bránky.

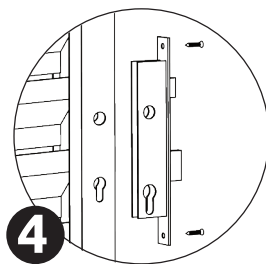
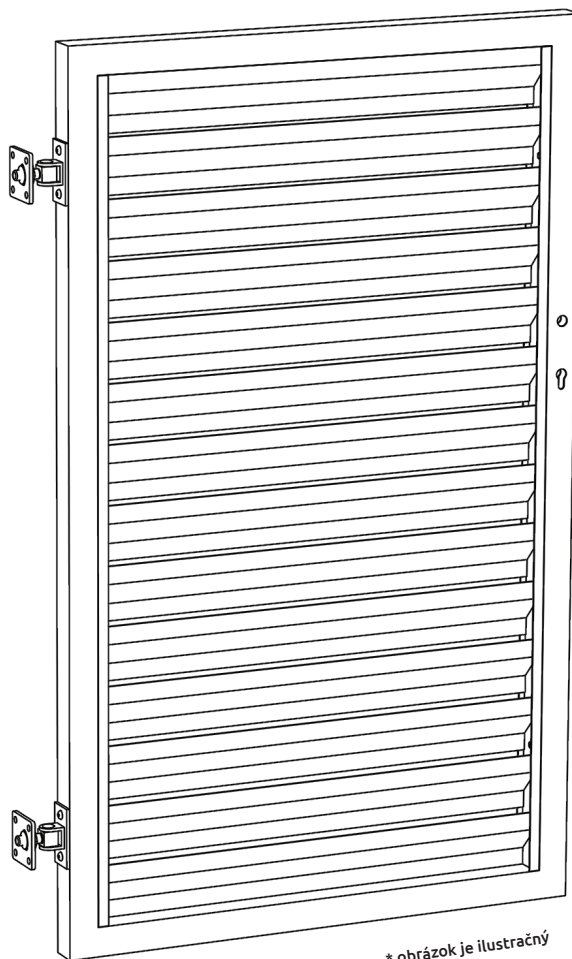

4 Zámok F uchytíme k rámu pomocou skrutiek D.

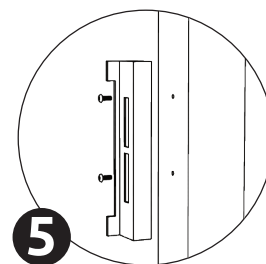

5 Navrtáme otvory Ø 6,8 mm. Narežeme závit M8 mm. Doraz bránky G uchytíme k stĺpiku pomocou skrutiek C.

Návod na inštaláciu brány a bránky

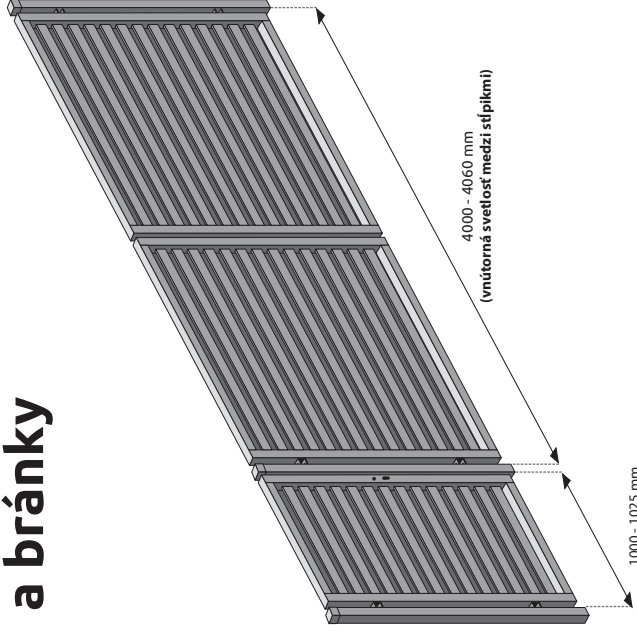

1 Označte miesto a polohu osadenia brány a bránky.

2 Vykopajte základy pre stĺpiky brány a bránky do Vami požadovanej hĺbky.

3 Predmontáž brány a bránky v horizontálnej polohe.

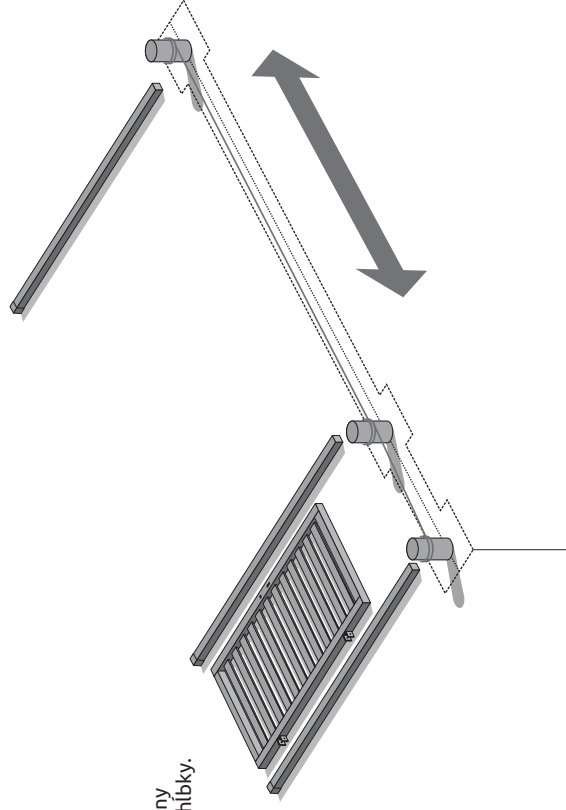

4 Takto poskladanú bránu stabilizujte pomocou drevených vzpier.

5 Poskladanú bránu a bránku umiestnite na miesto zabudovania. Nezabudnite skontrolovať a vycentrovať bránu pomocou stĺpkovej vodováhy.

6 Výškovú polohu stabilizujte pomocou klinov resp. montážneho vankúšika.

7 Zabetonujte stĺpiky.



8 Po vytvrdnutí betónovej zmesi odstráňte stabilizačné dosky a osadte stredový doraz a koncové dorazy do vyznačených polôh (dorazy nie sú súčasťou balenia).

9 V prípade záujmu o ovládanie brány pohonom použite pohon s integrovanými koncovými dorazmi a spomalením pred koncovými polohami.

